

Intelligent charging solutions for **EV Chargers**



CirCarLife (Circontrol's eMobility Division) comprises a set of products and solutions designed to facilitate the Electric Vehicle (EV) charging.

CirCarLife aims to provide user-friendly solutions for electric vehicle charging in different scenarios, such as urban streets, intercity roads and public or private car parks, for multiple or single users.

CirCarLife's product portfolio offers a wide product range that covers slow charging (AC) and fast charging (DC). Circontrol is an European Leader in EVSE with presence in 56 countries and more than 50.000 charging points installed worldwide.



EV Chargers

Application by market segments	6
WB eHome	8
WB eNext	10
BeON	12
WB Smart	14
WB eVolve Smart	16
Post eVolve Smart	18
Raption 50	20

EV Charging Solutions 22

Master-Slave	24
DLM	28
Cosmos	30

After Sales Support 32

Who drives an EV?

The presence of an EV charger on the street or a silent EV car suddenly crossing the road were rare things not so long ago, but they are becoming more common every day and forecasts show that they will be a strong reality sooner than later.

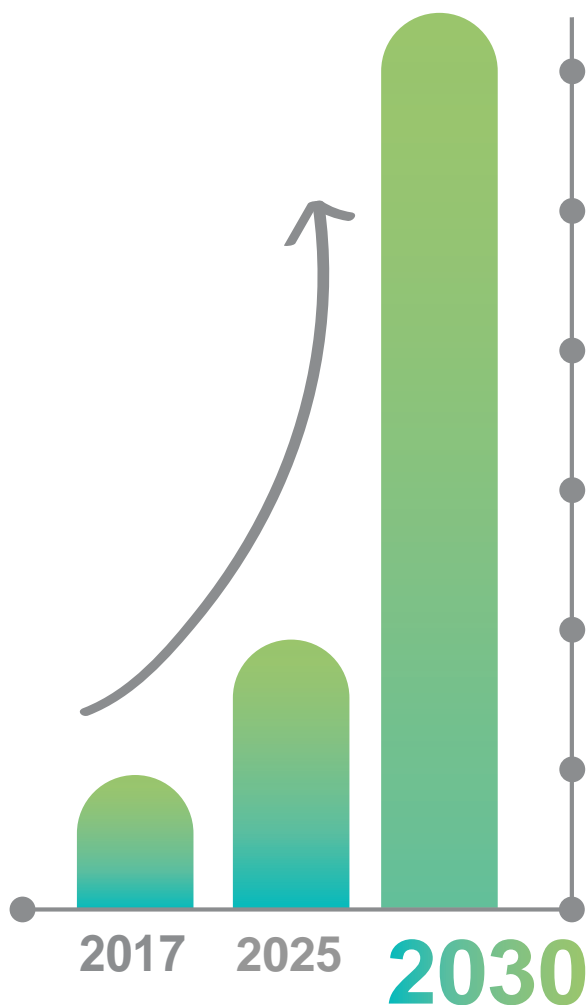

Forecasts show sales of electric vehicles increasing from a record

1.1 million worldwide in 2017, to 11 million in 2025 and then surging to 30 million in 2030.

By 2040, 55% of all new car sales and 33% of the global fleet will be electric.

*According to Bloomberg New Energy Finance

This rising interest for EVs makes even more important to know more about these early adopters.

Who are they?

Mostly they are



Males



41 years old



Richer than the average



Living in small cities

Why did they buy an EV?

Main reason



Environmental Benefits



Financial Savings



Interest in new technology



Driving benefits (instant torque or smooth & quiet)

Application by market segments

Charging Station for Electric Vehicles





Market Segments

WallBox



Post



QC



WB eHome

WB eNext

WB Smart

WB eVolve Smart

Post eVolve Smart

Raption 50



Workplace & Fleets

Designed for companies with an EV fleet or employees owning an EV. It allows them to charge it while they are at work.



Retail

Perfect for malls or commercial areas. Customers are able to load their EV's battery while they are shopping.



Hospitality

Ideal for charging EV in hotels, restaurants or leisure centres, among others. Customers can leave it charging and pick up the car after their stay.



Private Home

Designed for a private charge of the EV while the owner is comfortably at home.



Condominium

Perfect for apartment blocks and communal areas.



Municipalities

Designed to be placed in a public area such as a public parking where many drivers will have access to this charging point.



Education & Healthcare

Ideal for Universities, hospitals or other public facilities where drivers can charge their EV while they are studying or doing any other activity.



Highway

Designed for offering the quickest charge and allow drivers to continue the journey in a short time.



CarPark

Perfect for both public and private parkings. A good solution for parking's owners as they enable communication between stations.



WallBox eHome

The ultimate solution for domestic EV charging



Application

Designed to be installed (both indoor and outdoor) at private houses, communal blocks, companies and other places where user authentication is not a requirement.

Concept Design

Taking into account that many times a domestic charger is considered an appliance, a nice design and a small size are key attributes that are to be contemplated.

Furthermore WallBox eHome series offers other attributes such as low-cost, robustness, and user-friendly operation.

Product highlights

- Compatible with **BeON sensor** (accessory), when combined with eHome is able to dynamically adjust the electric vehicle's consumption according to the available power of the installation, avoiding the risk of blackout and/or having to upgrade the existing installation (resulting on a lower initial investment).
- The **frontal LED bar** not only informs the user about the charger status (e.g. operative, faulty...) but also EV charging status; charging (dynamic blue light) vs charged (static blue light).
- Its **frontal key-locked door with electrical protections** (optional) not only provides an easy access in case the protection has tripped but protects the user against electrical shock. It can also be used as a user authentication method (using the protection as a ON/OFF switch).
- The charger's **housing** is made of ABS plastic which is both robust and UV resistant, providing protection against both mechanical stress and severe environmental conditions (which increases the charger lifespan and avoids its replacement in just a few years).
- Its well-thought-out shape allows the cable to be rolled up and keep it tidy and unbroken while the charger is not being used.
- Simple user operation by its **Plug 'n' Charge** mode that avoids the user obligation of authentication by means of an RFID card, phone or equivalent method.
- This series also includes a **selector switch** that facilitates the setup of the charger maximum output current (reducing installation time and cost).
- **Remote charging activation** is also offered by means of an ON/OFF external input signal (e.g. timer).
- WallBox eHome series provides a reserved space in case you want to **have your own brand on it**.

WallBox eHome Series

General Specifications





Enclosure rating	IP54 / IK10
Enclosure material	ABS-PCV0
Operating temperature	-5 °C to +45 °C
Ambient temperature storage	-40 °C to +60 °C
Operating humidity	5 % to 95 % Non-condensing
Light beacon	RGB colour indicator
Current setup	Onboard dipswitch
Dimensions (D x W x H)	115x180x315 mm
Weight	4 kg
Cable length	5 meters
External input	Remote charging activation

Optional devices

Meter*	Active Energy Class 1 (IEC 62053-21)
Low temperature kit	-30 °C to +45 °C
Safety protection*	RCD Type A / B (30mA)
Power limit control	BeON sensor
Cable support	Metallic holder

* When ordered, easy access with frontal key locked door.

Models Specifications

Model	T1C16	T1C32	T2C16	T2C32
AC power supply	1P + N + PE	1P + N + PE	1P + N + PE	1P + N + PE
AC voltage	230 VAC +/-10%	230 VAC +/-10%	230 VAC +/-10%	230 VAC +/-10%
Maximum current	16 A	32 A	16 A	32 A
Maximum power	3,7 kW	7,4 kW	3,7 kW	7,4 kW
Connection	Type 1 Cable 	Type 1 Cable 	Type 2 Cable 	Type 2 Cable 

Circontrol collaborates with the main EV car makers



NISSAN



VOLKSWAGEN

And many more...

WallBox eNext

The perfect EV Charger for your needs

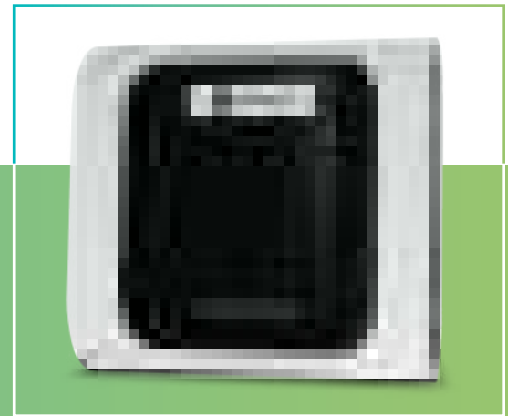

Application

Designed to be installed (both indoor and outdoor) at private houses, communal blocks, workplaces and car parks.

Concept Design

eNext has been conceived to simplify the charging process. We developed Presence Recognition, a feature that allows the user to start charging without any interaction with the device. As soon as the approved user is detected by Bluetooth and the cable is connected to the car, the charging process starts.

Regarding the external design, we keep the black and white colors as the core design concept while introducing curved lines and rounded shapes. The appropriate proportions and the perfect size, along with the black piano combined with white matt makes the eNext series the best choice to match any wall.

Product highlights

- **An APP** to control and configure the eNext: language configuration, user authentication, Wallbox diagnosis and firmware upgrades, among others.
- **Presence recognition by smartphone's Bluetooth**, so user authentication is confirmed simply by proximity.
- **Remote charging activation** is also offered by means of an ON/OFF external input signal (e.g. timer).
- **Timetable programming** to accommodate the charging session to the energy hourly rates.
- Ready for internal integration of electrical protections.
- Includes **welding contactor detection** that meets with IEC 61851-1 for safety protection.
- WallBox eNext series provides a reserved space in case you want to **have your own brand** on it.
- **DC leakages detection** can be ordered as an optional. Thus, in conjunction with the welding contactor and RCD A guarantees the highest safety protection.
- Compatible with **BeON sensor** (accessory), when combined with eNext is able to dynamically adjust electric vehicle's consumption according to the available power of the installation.
- The **frontal LED bar** not only informs the user about the charger status (e.g. operative, faulty...) but also EV charging status; charging (dynamic blue light) vs charged (static blue light).
- The charger's **housing** is made of ABS plastic which is both robust and UV resistant, providing protection against both mechanical stress and severe environmental conditions.

WallBox eNext Series



General Specifications

Enclosure rating	IP54 / IK10
Enclosure material	ABS / PC
Operating temperature	-5 °C to +45 °C
Ambient temperature storage	-40 °C to +60 °C
Operating humidity	5 % to 95 % Non-condensing
Light beacon	RGB colour indicator
Power limit control	Mode 3 PWM control according ISO/IEC 61851-1
Dimensions (D x W x H)	200 x 335 x 315 mm
Weight	4 kg
External input	Remote charging activation
Wireless communication	Bluetooth v4.2 + BLE

Optional devices

Low temperature kit	-30 °C to +45 °C
Protections	MCB (Curve C) DC 6mA leakage detection RCBO (RCD Type A + MCB)
Power limit control	BeON sensor
Type 2 socket protection	Locking System
Type 2 charging socket	Shutter
Tethered cable (straight or spring)	Type 1 Type 2
Cable support	Connector holder Cable roller
Pedestal	

Model Specifications

Model	S	T
AC power supply	1P + N + PE	3P + N + PE
AC input voltage	230 VAC +/-10%	400 VAC +/- 10%
Maximum input current	32 A	32 A
Maximum input power	7,4 kW	22 kW
Number of plugs	1	1
Maximum output power per outlet	7,4 kW	22 kW
Maximum output current per outlet	32 A	32 A
AC output voltage	230 VAC (1P + N + PE)	400 VAC (3P + N + PE)
Socket Type	1 x Type 2 Socket 	1 x Type 2 Socket 

Pedestal

A good choice when there is no wall.

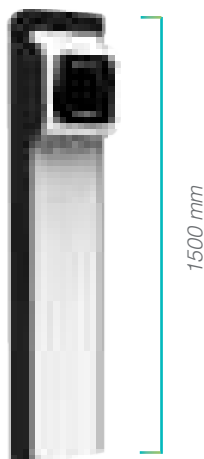

Material:
Aluminium 5754

Weight:
10 Kg

Dimensions (H x W x D):
1500x373x150 mm

Promotional Totem

A smart marketing tool for car dealers, showrooms, exhibitions, etc.



Material:
Polystyrene
(1,5 mm width)

Weight:
4 Kg

Dimensions (H x W x D):
1550x400x250 mm

BeON

The ultimate EV charger synchronized with your home



- Would you like to charge your EV faster without the need of a costly installation upgrade?
- Would you like to avoid any risk of blackout when using the appliances and charging the EV at the same time?
- Would you like to have all this without a huge investment?

BeON takes a new step in domestic EV charging allowing you to charge your vehicle while using your appliances.

Its intelligent sensor, easily added to the usual protection panel at home, dynamically adjusts electric vehicle's consumption if the house system is about to be overloaded.

eHome BeON measures and interprets the housing consumption, generates the corresponding signal and sends it to WallBox eHome charging station, which interprets and modifies its output current accordingly.

eHome BeON uses the moments when the house is using less power to charge your EV saving money and energy.

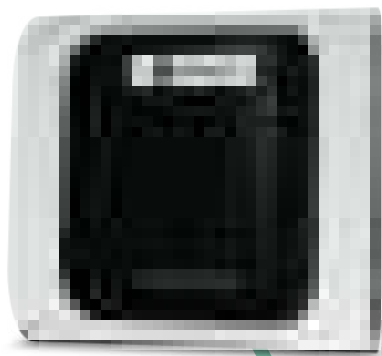

Compatible with eHome and eNext

Intelligent sensor

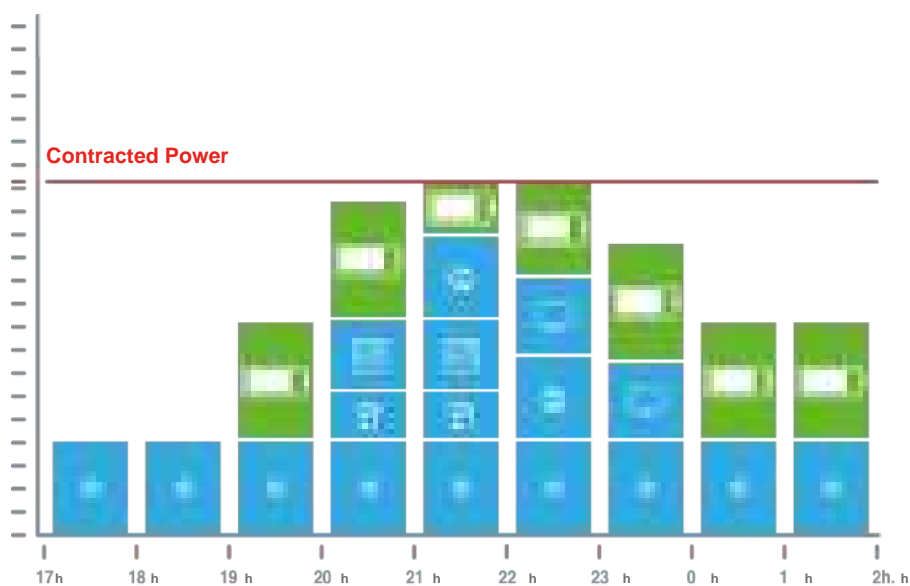

Product dimensions

It is so small that will fit everywhere

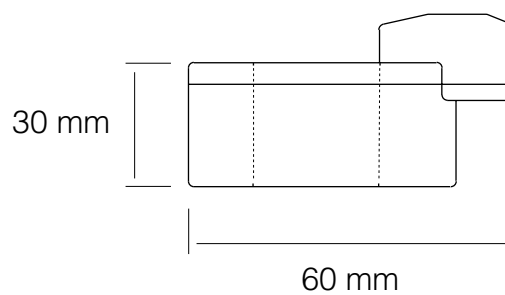
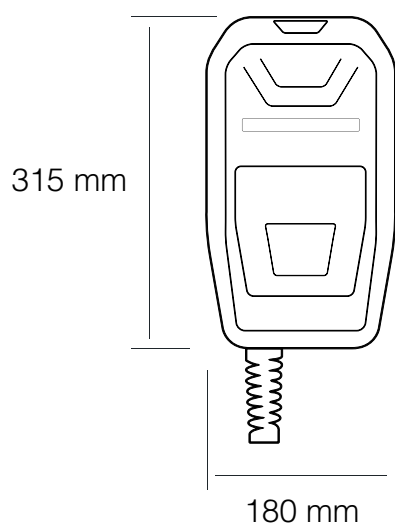

WallBox Smart

Perfect for improving user and operator experience

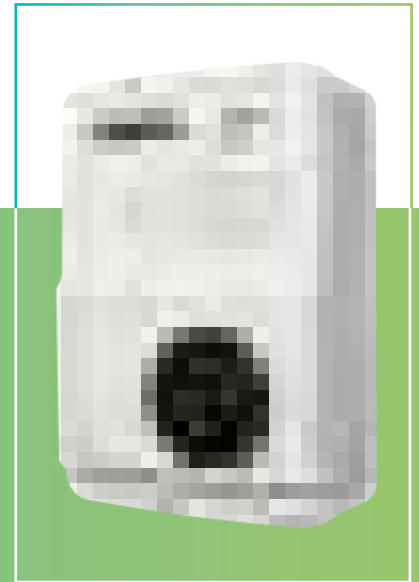

Application

Designed to be installed in both public access environments (urban spaces, shopping centres, parking lots, airports...) and private ones (homes, communal blocks, companies fleets...) where their intelligence and communications capabilities offer a range of possibilities that improve the user and/or operator experience.

Concept Design

Nowadays, the concept of intelligent car park combined with sophisticated users demands intelligent EV chargers with the possibility of having connection to a cloud based software or backend.

Installing a Smart WallBox network in a carpark allows performing an intelligent energy management of several charging station simultaneously where not enough power is available.

Product highlights

For Charge Point Operator / Owner

- The **Embedded Load Management** allows a lower TCO (Total Cost of Ownership) by charging two EVs simultaneously even when the charger is not supplied with its maximum output power.
- About the charger's **Housing, ABS plastic** has been selected in a robust structural design that provides protection to both mechanical stress and severe environmental conditions, increasing the charger lifespan and avoiding its replacement in just a few years.
- In terms of **Communication**, either by its Ethernet port (by default) or 3G/GPRS modem (optional) the charger can be connected to a back-office system (by means of OCPP) obtaining benefits such as user management, billing, remote error diagnostic, etc.
- Ready for **Dynamic Load Management** network integration. Smart Wallbox series can be integrated with Circontrol Scada Software and make simultaneous EV charge easier, faster and cheaper.

For Charge Point User

- Clear charging instructions and plug status are shown using a backlight display, increasing user satisfaction, especially useful when the charger has been previously reserved by another user.
- Smart Wallbox series offers a flexible authentication, meaning that the user can either authenticate before or after connecting the cable to the EV. Additionally, the authentication process can also be disabled for a 'plug & charge' use mode.



WallBox Smart Series



General Specifications







Network connection	10/100BaseTX (TCP-IP)
Interface protocol	OCPP 1.5 (1.6 J optional)
Enclosure rating	IP54 / IK10
Enclosure material	ABS
Operating temperature	-5°C to 45°C
Ambient temperature storage	-40°C to +60°C
Operating humidity	5% to 95% Non-condensing
Light beacon	RGB colour indicator
Display	LCD Multi-language
Power limit control	Mode 3 PWM control according ISO/IEC 61851-1
Dimensions (D x W x H)	Single: 125x225x320 mm Dual: 125x442x350 mm
Weight	Single: 4 kg Dual: 6 kg

RFID Reader	ISO / IEC14443A / B MIFARE Classic/DESFire EV1 ISO 18092 / ECMA-340 NFC 13.56MHz
Meter	Class 1 - EN50470-3
Type 2 Socket Protection	Locking system
Compatible with DLM	
Optional devices	
MID Meter	MID Class 1 - EN50470-3
Low temperature kit	-30°C to +45°C
Cable support	Optional (included at WallBox with tethered cable)
Pedestal	Single: for one plug WallBox Dual: for two plugs WallBox
Type 2 Charging Socket	Shutter
Wireless Communication	3G / GPRS / GSM

Models Specifications

Model	WBC-SMART	WBC32-SMART	WBMC-SMART
AC power supply	1P + N + PE	1P + N + PE	1P + N + PE
AC Voltage	230 VAC +/-10%	230 VAC +/-10%	230 VAC +/-10%
Maximum input current	16 A	32 A	32 A
Maximum input power	3,7 kW	7,4 kW	7,4 kW
Number of plugs	1	1	1
Maximum output power per outlet	3,7 kW	7,4 kW	7,4 kW
Maximum output current per outlet	16 A	32 A	32 A
AC output voltage	230 VAC (1P + N + PE)	230 VAC (1P + N + PE)	230 VAC (1P + N + PE)
Connection	1 x Type 1 Cable (5m) 	1 x Type 1 Cable (5m) 	1 x Type 2 Cable (5m) 

Model	WBMC-SMART-TRI	WBM-SMART	WBM-SMART-TRI
AC power supply	3P + N + PE	1P + N + PE	3P + N + PE
AC Voltage	400 VAC +/-10%	230 VAC +/-10%	400 VAC +/-10%
Maximum input current	32 A	32 A	32 A
Maximum input power	22 kW	7,4 kW	22 kW
Number of plugs	1	1	1
Maximum output power per outlet	22 kW	7,4 kW	22 kW
Maximum output current per outlet	32 A	32 A	32 A
AC output voltage	400 VAC (1P + N + PE)	230 VAC (1P + N + PE)	400 VAC (3P + N + PE)
Connection	1 x Type 2 Cable (5m) 	1 x Type 2 Socket (lock system) 	1 x Type 2 Socket (lock system) 

Model	WB-MIX-SMART	WB2M-SMART	WB2M-SMART-TRI
AC power supply	1P + N + PE	1P + N + PE	3P + N + PE
AC Voltage	230VAC +/-10%	230 VAC +/-10%	400 VAC +/-10%
Maximum input current	48 A	64 A	64 A
Maximum input power	11 kW	14,7 kW	44 kW
Number of plugs	2	2	2
Outlet A	Maximum output power	7,4 kW	22 kW
	Maximum output current	32 A	32 A
Outlet B	Maximum output power	3,7 kW	22 kW
	Maximum output current	16 A	32 A
AC output voltage	230 VAC (1P + N + PE)	230 VAC (1P + N + PE)	400 VAC (3P + N + PE)
Connection	1 x Type 2 Socket (lock system) + 1 x CEE/7  	2 x Type 2 Socket (lock system)  	2 x Type 2 Socket (lock system)  

WallBox eVolve Smart

The ultimate design for a WallBox with communications

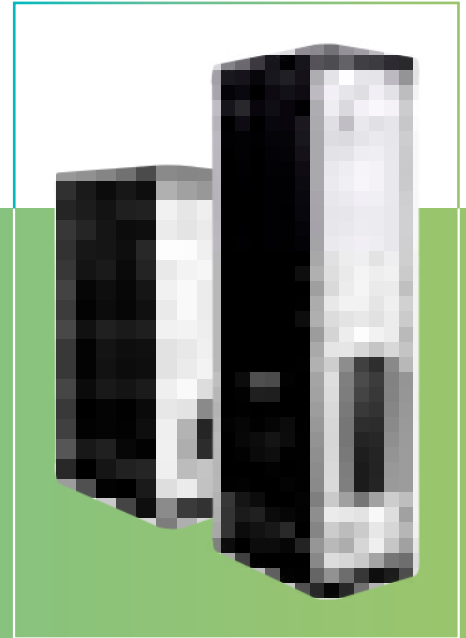

Application

Designed to be installed in both public access environments (urban spaces, shopping centres, parking lots, airports, petrol stations ...) and private ones (companies, community car park sites...) where their intelligent capabilities offer a range of possibilities which improve the user and/or operator experience.

Concept Design

Nowadays, the concept of smart cities demands an innovative design for its urban equipment, especially for EVSE (EV Supply Equipment) due to its innovative nature. With its stylised shape and modern lines, eVolve series meets this demand.

In the same way, not only external design has been taken into account but also the daily conditions (both operational and environmental) EVSE have to withstand.

Product highlights

For Charge Point Operator / Owner

- The **Embedded Load Management** allows a lower TCO (Total Cost of Ownership) by charging two EVs simultaneously.
- Its **frontal key-locked door** provides an easy access to the inside of the charger which results in a lower OpEx (Operating Expenditure) due to a quicker installation and service (preventive/corrective). Moreover, it allows the charger to be installed next to a wall, optimising the available space.
- About the charger's **housing**, aluminium and ABS plastic have been combined in a robust structural design that provides protection to both mechanical stress and severe environmental conditions, increasing the charger lifespan and avoiding its replacement in just a few years.
- In terms of **communication**, either by its Ethernet port (by default) or 3G/GPRS modem (optional) the charger can be connected to a back-office system (by means of OCPP) obtaining benefits such as user management, billing, remote error diagnostic, etc.
- To comply with the most demanding requirements regarding billing, eVolve series includes **MID certified meters**.
- **Available in two sizes**, the small one with no protections and the large one with protections.

For Charge Point User

- Clear charging instructions and plug status are shown using a **backlight display**, increasing user satisfaction, especially useful when the charger has been previously reserved by another user.
- eVolve series offers a **flexible authentication**, meaning that the user can either authenticate before or after connecting the cable to the EV. Additionally, the authentication process can also be disabled for a 'plug & charge' use mode.
- The **accessibility for the disabled** has also been considered, complying with international standards regarding the height of connectors/display that facilitates its operation.
- eVolve series includes the necessary **electrical protections** (optional) not only to minimize the human safety risk of electrical shock but also to ensure the maximum uptime due to independent protections per connector.



WallBox eVolve Smart Series

General Specifications

Network connection	10/100BaseTX (TCP-IP)	Meter	MID Class 1 - EN50470-3
Interface protocol	OCPP 1.5 (1.6 J optional)	Power output management	Embedded Load Management
Enclosure rating	IP54 / IK10	Type 2 Socket Protection	Locking System
Enclosure material	Aluminium & ABS	Compatible with DLM	
Enclosure door lock	Key lock	Optional devices	
Enclosure access	Frontal door	Low temperature kit	-30 °C to +45 °C
Operating temperature	-5 °C to +45 °C	Electrical protection Type A*	Overcurrent: MCB (curve C) Safety: RCD Type A (30mA) Autorecovery function optional
Ambient temperature storage	-40 °C to +60 °C	Electrical protection Type B*	Overcurrent: MCB (curve C) Safety: RCD Type B (30mA) Autorecovery function optional
Operating humidity	5 % to 95 % Non-condensing	Type 2 Charging Socket	Shutter
Light beacon	RGB colour indicator	Wireless Communication	3G / GPRS / GSM
Display	LCD Multi-language	Tethered Cable (spring)* (Cable length: 4 m)	Type 1 + Type 1 Type 2 + Type 2 Type 2 + Type 2 Socket
Power limit control	Mode 3 PWM control according ISO/IEC 61851-1	RFID Extension	Legic Advant / Legic Prime ISO 15693 / ISO 18092, Sony FeliCa
Dimensions (D x W x H)	Small: 222x382x628 mm (Model S & T without protections) Large: 222x382x928 mm	Customization	Frontal Labelling
Weight	Small: 25 kg Large: 30 kg	Anti-vandal Key	
RFID Reader	ISO / IEC14443A / B MIFARE Classic/DESFire EV1 ISO 18092 / ECMA-340 NFC 13.56MHz		

*Not available in model TM4

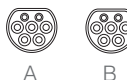
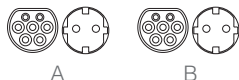
Models Specifications

Model	S	T	TM4	
AC power supply	1P + N + PE	3P + N + PE	3P + N + PE	
AC input voltage	230 VAC +/-10%	400 VAC +/-10%	400 VAC +/-10%	
Maximum input current	64 A	64 A	64 A	
Maximum input power	14,7 kW	44 kW	44 kW	
Number of plugs	2	2	4	
Outlet A	Maximum output current	32 A	32 A	16 A
	Maximum output power	7,4 kW	22 kW	3,7 kW
	AC output voltage	230 VAC (1P + N + PE)	400 VAC (3P + N + PE)	400 VAC (3P + N + PE)
Outlet B	Maximum output current	32 A	32 A	16 A
	Maximum output power	7,4 kW	22 kW	3,7 kW
	AC output voltage	230 VAC (1P + N + PE)	400 VAC (3P + N + PE)	400 VAC (3P + N + PE)
Protections	Small	No	No	Not Available
	Large	Yes	Yes	No
Connection	2x Type 2 Socket (lock system) 	2x Type 2 Socket (lock system) 	2x Type 2 Socket (lock system) 	2x CEE/7 

Post eVolve Smart

AC Charging Post with intelligent capabilities

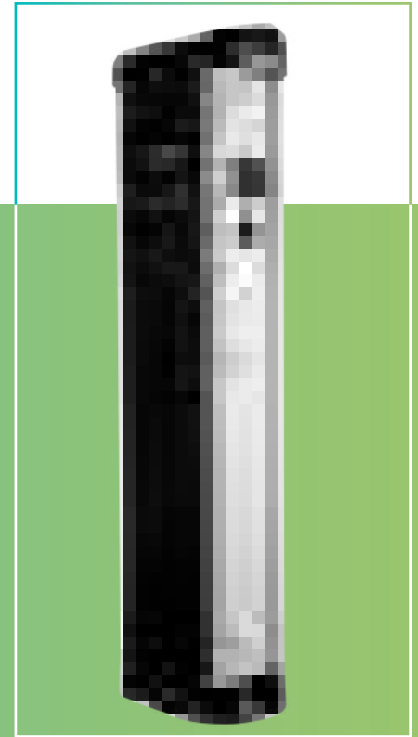

Application

Designed to be installed in both public access environments (urban spaces, shopping centres, parking lots, airports, petrol stations ...) and private ones (companies, community car park sites...) where their intelligent capabilities offer a range of possibilities which improve the user and/or operator experience.

Concept Design

Nowadays, the concept of smart cities demands an innovative design for its urban equipment, especially for EVSE (EV Supply Equipment) due to its innovative aspect. With its stylised shape and modern lines, eVolve series meets this demand.

In the same way, not only external design has been taken into account but also the daily conditions (both operational and environmental) EVSE have to withstand.

Product highlights

For Charge Point Operator / Owner

- The **Embedded Load Management** allows a lower TCO (Total Cost of Ownership) by charging two EVs simultaneously even when the charger is not supplied with its maximum output power.
- Its **frontal key-locked door** provides an easy access to the inside of the charger which results in a lower OpEx (Operating Expenditure) due to a quicker installation and service (preventive/corrective). Moreover, it allows the charger to be installed next to a wall, optimising the available space.
- About the charger's **housing**, aluminium and ABS plastic have been combined in a robust structural design that provides protection to both mechanical stress and severe environmental conditions, increasing the charger lifespan and avoiding its replacement in just a few years.
- In terms of **communication**, either by its Ethernet port (by default) or 3G/GPRS modem (optional) the charger can be connected to a back-office system (by means of OCPP) obtaining benefits such as user management, billing, remote error diagnostic, etc.
- To comply with the most demanding requirements regarding billing, eVolve series includes **MID certified meters**.

For Charge Point User

- Clear charging instructions and plug status are shown using a **backlight display**, increasing user satisfaction, especially useful when the charger has been previously reserved by another user.
- eVolve series offers a **flexible authentication**, meaning that the user can either authenticate before or after connecting the cable to the EV. Additionally, the authentication process can also be disabled for a 'plug & charge' use mode.
- The **accessibility for the disabled** has also been considered, complying with international standards regarding the height of connectors/ display that facilitates its operation.
- eVolve series includes the necessary **electrical protections** not only to minimize the human safety risk of electrical shock but also to ensure the maximum uptime due to independent protections per connector.

Post eVolve Smart Series

General Specifications









Network connection	10/100BaseTX (TCP-IP)
Interface protocol	OCPP 1.5 (1.6 J optional)
Enclosure rating	IP54 / IK10
Enclosure material	Aluminium & ABS
Enclosure door lock	Key lock
Enclosure access	Frontal door
Operating temperature	-5 °C to +45 °C
Ambient temperature storage	-40 °C to +60 °C
Operating humidity	5 % to 95 % Non-condensing
Light beacon	RGB colour indicator
Display	LCD Multi-language
Power limit control	Mode 3 PWM control according ISO/IEC 61851-1
Dimensions (D x W x H)	450x290x1550 mm
Weight	55 kg
RFID Reader	ISO / IEC14443A / B MIFARE Classic/DESFire EV1 ISO 18092 / ECMA-340 NFC 13.56MHz

Meter	MID Class 1 - EN50470-3
Power output management	Embedded Load Management
Overcurrent protections	MCB (curve C)
Safety protection	RCD Type A (30mA) Autorecovery function optional
Type 2 Socket Protections	Locking System
Compatible with DLM	

Optional devices

Low temperature kit	-30 °C to +45 °C
Safety protection	RCD Type B (30mA) Autorecovery function optional
Surge protection	Four pole transient surge protector IEC 61643-1 (class II)
Type 2 Charging Socket	Shutter
Wireless Communication	3G / GPRS / GSM
Anti-vandal Key	
Anti-vandal Door	Not available for TM4
Tethered Cable (<i>spring</i>) (Cable length: 4 m)	Type 1 + Type 1 Type 2+ Type 2 Type 2 + Type 2 Socket
RFID Extension	Legic Advant / Legic Prime ISO 15693 / ISO 18092, Sony FeliCa

Models Specifications

Model	S	T	C63	TM4		
AC power supply	1P + N + PE	3P + N + PE	3P + N + PE	3P + N + PE		
AC input voltage	230 VAC +/-10%	400 VAC +/-10%	400 VAC +/- 10%	400 VAC +/-10%		
Maximum input current	64 A	64 A	63 A	64 A		
Maximum input power	14,7 kW	44 kW	43 kW	44 kW		
Number of plugs	2	2	1	4		
Outlet A	Maximum output current	32 A	32 A	32 A	16 A	
	Maximum output power	7,4 kW	22 kW	43 kW	22 kW	3,7 kW
	AC output voltage	230 VAC (1P + N + PE)	400 VAC (3P + N + PE)	400 VAC (3P + N + PE)	400 VAC (3P + N + PE)	230 VAC (1P + N + PE)
Outlet B	Maximum output current	32 A	32 A	32 A	16 A	
	Maximum output power	7,4 kW	22 kW	22 kW	3,7 kW	
	AC output voltage	230 VAC (1P + N + PE)	400 VAC (3P + N + PE)	400 VAC (3P + N + PE)	400 VAC (3P + N + PE)	230 VAC (1P + N + PE)
Connection	2x Type 2 Socket (lock system)	2x Type 2 Socket (lock system)	1 x Type 2 Cable (4m)	2x Type 2 Socket (lock system)	2x CEE/7	
	 	 		 	 	

Customization Examples

eVolve series offers a wide frontal surface that can be easily customized.



Raption 50

DC Fast Charging Station for Electric Vehicles

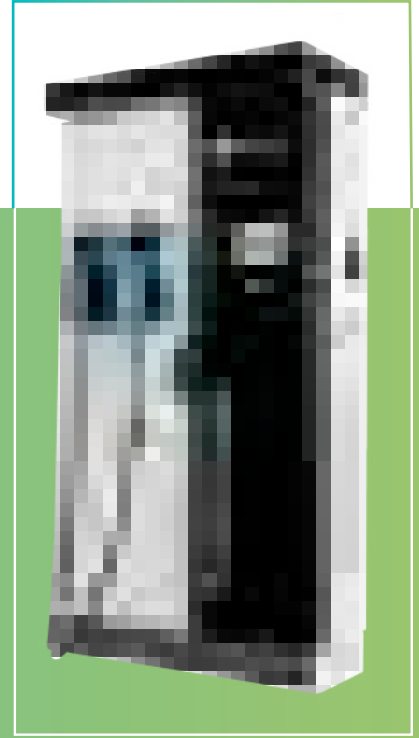

Application

Designed to be installed in both public access environments (urban spaces, shopping centres, airports, road-side rest areas...) and private ones (companies with EV fleet, taxi stop stations...) where vehicles need to be ready to continue their journey in less than half an hour.

Concept Design

Conceived to address the main problem identified by Charge Point Owners / Operators when Fast Charging (low uptime), Raption 50 series bases its functioning in state-of-the-art modular power technology.

Another key attribute considered has been its external design. Sophisticated, slim and robust are just some attributes that can be used to describe this series and make it ideal for any type of site (from the most stylish urban area to industrial sites).

Product highlights

For Charge Point Operator / Owner

- Its **modular power technology** ensures a very high uptime (reducing the non-operation expenditure) since in case of power module failure the rest of modules continue charging.
- Lower energy consumption (and therefore OpEx) is achieved due to a **sustained high efficiency level** resulting from disconnecting power modules when lower charging power is requested by the EV.
- The modular architecture allows **power scalability** (e.g. from 25kW to 50kW) to meet present and future EV growing battery demands.
- It offers a unique **connector care** concept by means of gun locking feature (optional) and cable floating design, which results on a reduction of cable breaking risk.
- Its **double frontal key-locked door** provides an easy access to the the charger for a quicker installation and service. Moreover, it allows the charger to be installed next to a wall, optimising the available space.
- Capable of being configured as a **Master for the Master-Slave** solution (p. 24).

For Charge Point User

- Its **8" touch-screen daylight readable** not only provides clear charging instructions (e.g. wrong EV shift position to start the charge) and plug status (e.g. reserved charge point) but also allows the user to select amongst several languages.
- User satisfaction is also increased due to its **build-in courtesy light** which both facilitates locating the charge point in dark areas and reading the messages contained in operator instruction labels.
- **Accessibility for the disabled** has also been considered, complying with international standards regarding the height of connectors/display that facilitates its operation.

**Available 480 V model for Mexico and other Latin America countries.*

Raption 50 Series

General Specifications

AC Power Supply	3P + N + PE
AC Voltage	400 V AC +/- 10%
Power Factor	>0,98
Efficiency	95 % at nominal output power
Frequency	50 / 60 Hz
Electrical input protection	Main breaker disconnection
Overcurrent protections	MCB
Safety protection	RCD 30mA Type A
Network connection	Ethernet 10/100BaseTX
Interface protocol	OCPP 1.5 (1.6 J optional)
Compliance	CE / Combo-2 (DIN 70121; ISO15118) EN61851-1; EN61851-23 CHAdeMO compatible
Enclosure rating	IP54 / IK10
Enclosure material	Stainless steel
Operating temperature	-30 °C to +50 °C
Ambient temperature storage	-40 °C to +60 °C
Operating humidity	5 % to 95 % Non-condensing
Socket protection	Locking System
RFID system	ISO / IEC14443A / B MIFARE Classic / DESFire EV1 ISO 18092 / ECMA-340 NFC 13.56MHz

Display HMI	8" anti vandal touch screen
Power limit control	DC & AC by software
DC cable length CCS	3 meters
DC cable length CHAdeMO	3 meters
AC cable length	3 meters
Lights for status indication	RGB colour indicator
Dimensions (D x W x H)	355x940x1800 mm (without cable engaged)
Weight	235 kg
Cooling system	Air cooling fans
Operational noise level	< 55 dBA
AC Meter	Complies with the EN 50470 (MID European standards) or IEC 62052-11

Optional devices	
Wireless Communication	4G LTE/WiFi Hotspot/GPRS/GSM
Surge protection	Four pole transient surge protector IEC 61643-1 (class II)
Safety protection	RCD type B
Cable Length	5.5m (all cables)
Anti-vandal connector protection	CHAdeMO, CCS (mechanical connector locking)
RFID Extension	Legic Advant / Legic Prime ISO 15693 / ISO 18092, Sony FeliCa

***25 kW DC version** Power output DC of 25 kW
(2 x 12,5 kW modules)

Models Specifications

Models	CCS CHA T2C63	CCS CHA T2S32	CCS CHA	CCS T2S32
Maximum AC input current	138 A (101 A*)	108 A (70 A*)	76 A (38 A*)	108 A (70 A*)
Required power supply capacity	96 kVA (70 kVA*)	75 kVA (48 kVA*)	53 kVA (26 kVA*)	75 kVA (48 kVA*)
Maximum output power	DC:50 kW (25 kW*) (@400 VDC) AC:43 kW	DC:50 kW (25 kW*) (@400 VDC) AC:22 kW	50 kW (25 kW*) (@400 VDC)	DC:50 kW (25 kW*) (@400 VDC) AC:22 kW
Output voltage range	DC: 50 - 500 V AC: 400 V	DC: 50 - 500 V AC: 400 V	DC:50 - 500 V	DC: 50 - 500 V AC: 400 V
Maximum output current	DC:125 A (63 A*) AC:63 A	DC:125 A (63 A*) AC:32 A	DC:125 A (63 A*)	DC:125A (63 A*) AC:32 A
Number of plugs	3	3	2	2
Connection	CCS 2 - JEVS G105 Type 2 Tethered cable	CCS 2 - JEVS G105 Type 2 Socket (Lock system)	CCS 2 - JEVS G105	CCS 2 Type 2 Socket (Lock system)

Models	CHA T2S32	CCS	CHA
Maximum AC input current	108 A (70 A*)	76 A (38 A*)	76 A (38 A*)
Required power supply capacity	75 kVA (48 kVA*)	53 kVA (26 kVA*)	53 kVA (26 kVA*)
Maximum output power	DC:50 kW (25 kW*) (@400 VDC) AC:22 kW	50 kW (25 kW*) (@400 VDC)	50 kW (25 kW*) (@400 VDC)
Output voltage range	DC: 50 - 500 V AC: 400 V	DC:50 - 500 V	DC:50 - 500 V
Maximum output current	DC:125 A (63 A*) AC:32 A	DC:125 A (63 A*)	DC:125A (63 A*)
Number of plugs	2	1	1
Connection	JEVS G105 Type 2 Socket (Lock system)	CCS 2	JEVS G105

EV Charging Solutions

Every challenge demands a **solution**.

EV charging easier, faster & cheaper.

Operating several charging points in one location represents some challenges and demands solutions to face them. Using devices, software or solutions that allow load management, monitoring and reporting has several advantages such as avoiding blackouts due to grid overloading, reducing installation and operational costs and being more efficient by collecting data of your charging network.

Why are our EV Charging Solutions important?



Avoid blackouts
due to limited grid capacity.



Reduce high Investment
avoiding installation upgrade.



Reduce operational costs
thanks to intelligent balancing of the load.



Make your management more efficient
thanks to monitoring.

Master-Slave



Master-Slave is the most cost-effective **solution** of having multiple charging points controlled through a single master unit. Moreover, it allows dynamic load management which enables automatic distribution of available power of your grid connection.

Dynamic Load Management



Dynamic Load Management (DLM) system is a **software** that allows charging several EVs simultaneously in less time using the available power more efficiently and balancing it among the EV chargers.

Cosmos



Cosmos is a **cloud-based platform for monitoring and reporting**. It is a platform designed to collect and store data from a specific set of EV chargers located in car parks, offices and communal blocks.

Master - Slave

The most cost-effective way for multiple charging

Application

Designed to minimize the initial investment (CAPEX) and the operating expenses (OPEX) when several chargers are required, this solution is a combination of a Master charger and a set of Slaves controlled by this Master. The whole system works as if all the chargers had smart capabilities.

Suitable for private installations such as workfleets or communities with a unique administrator, but also suitable for public access environment such as shopping center, parking lots, airports and others.

Concept Design

It shares the external concept design with the acclaimed eVolve series, so beyond its modern lines and robust housing, harsh weather conditions and user-friendly operation have been considered.

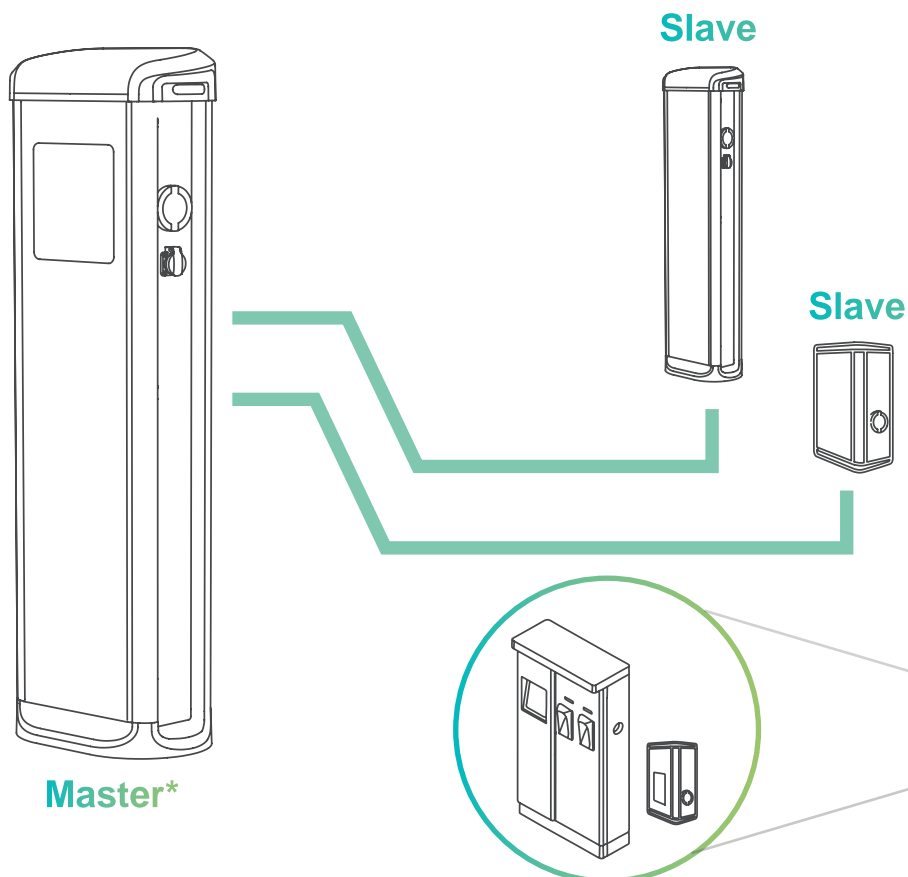

*Raption 50 and WallBox eVolve are also available for Master.

Product highlights

- The Master charger is **capable of balancing the available power** based on the number of charge points in use, thus the total power required to provide the total load gets substantially reduced. This may represent a cost reduction in the electrical connection set up and a cost saving due to a minor energy contract.
- Also, by centralizing the smart capabilities into the Master, the hardware of the Slaves gets reduced, so combining Master-Slave is the **best choice to minimize the hardware cost**.
- A **single modem** in the Master unit can be used for remote connection and back-office system integration (by means of OCPP 1.5), so communication fees also get reduced avoiding extra OPEX cost.
- **The Master can operate up to 8 Slaves** (max. 18 charging points including the Master) managing the load and user authentication.
- For car parks without OCPP backend, standalone configuration offers **load balancing feature and user control through RFID**.
- Its **frontal key-locked door** provides an easy access to the inside of the charger which results in a lower OPEX (Operating Expenditure) due to a quicker installation and service (preventive/corrective). Moreover, it allows the charger to be installed next to a wall optimising the available space.
- Its **8" daylight readable touch-screen** not only provides clear charging instructions (e.g. wrong EV shift position to start the charge) and plug status (e.g. reserved charge point) but also allows the user to select amongst several languages.
- To comply with the most demanding requirements regarding billing, eVolve series includes **MID certified meters**.
- eVolve series include the necessary **electrical protections** not only to minimize the human safety risk of electrical shock but also to ensure the maximum uptime due to independent protections per connector.

Post Master-Slave



WallBox Master-Slave



Master - Slave Post

General Specifications

Enclosure rating	IP54 / IK10
Enclosure material	Aluminium & ABS
Enclosure door lock	Key lock
Enclosure access	Frontal door
Operating temperature	-5 °C to + 45 °C
Ambient temperature storage	-20 °C to + 60 °C
Operating humidity	5 % to 95 % Non-condensing
Meter	MID Class 1 - EN50470-3
Light beacon	RGB colour indicator
Power limit control	Mode 3 PWM control according ISO/IEC 61851-1
Dimensions	450 x 290 x 1550 mm
Weight	55 kg
Power Output Management	Embedded Load Management
Overcurrent protections	MCB (Curve C)
Safety protection	RCD Type A (30mA)
Type 2 Socket Protection	Locking System

Master

Network connection	10/100TX (TCP-IP)
Interface protocol	OCPP 1.5 (1.6 Optional)
Display HMI	8" anti vandal touch screen
RFID Reader	ISO/IEC 14443 A/B MIFARE Classic/DESFire EV1 ISO 18092 ECMA-340 NFC 16.53MHz

Slave

Master Communication	Ethernet UTP
----------------------	--------------

Optional devices

Low Temperature Kit	-30 °C to +45 °C
Safety Protection	RCD Type B (30mA)
Surge Protection	Four pole transient surge protector IEC 61643-1 (class II)
Type 2 Charging socket	Shutter
Wireless communication (only in Master)	4G LTE/WiFi Hotspot/GPRS/GSM
Anti Vandal Key	
Tethered cable (spring) (cable length: 4m)	Type 1 + Type 1
	Type 2 + Type 2
	Type 2 + Type 2 socket
Network hub (only available in Master)	Switch TCP ethernet 8 ports
	Switch TCP ethernet 12 ports
RFID Extension	Legic Advant / Legic Prime ISO 15693 / ISO 18092, Sony FeliCa

Models Specifications

Models	Master S One	Master T One	Master or Slave S	Master or Slave T	Slave C63	
AC power supply	1P + N + PE	3P + N + PE	1P + N + PE	3P + N + PE	3P + N + PE	
AC input voltage	230 VAC +/-10%	400 VAC +/-10%	230 VAC +/-10%	400 VAC +/-10%	400 VAC +/-10%	
Maximum input current	32 A	32 A	64 A	64 A	63 A	
Maximum input power	7,4 kW	22 kW	14,8 kW	44 kW	44 kW	
Number of plugs	1	1	2	2	1	
Outlet A	Maximum output current	32 A	32 A	32 A	63 A	
	Maximum output power	7,4 kW	22 kW	7,4 kW	43 kW	
	AC output voltage	230 VAC (1P + N + PE)	400 VAC (3P + N + PE)	230 VAC (1P + N + PE)	400 VAC (3P + N + PE)	400 VAC (3P + N + PE)
Outlet B	Maximum output current		32 A	32 A		
	Maximum output power		7,4 kW	22 kW		
	AC output voltage		230 VAC (1P + N + PE)	400 VAC (3P + N + PE)		
Connection	Master	1x Type 2 Socket (lock system)	1x Type 2 Socket (lock system)	2x Type 2 Socket (lock system)	2x Type 2 Socket (lock system)	Not available
	Slave	Not available	Not available	2x Type 2 Socket (lock system)	2x Type 2 Socket (lock system)	1 x Type 2 Cable (4m)

Master - Slave WallBox

General Specifications

Enclosure rating	IP54 / IK10
Enclosure material	Aluminium & ABS
Enclosure door lock	Key lock
Enclosure access	Frontal door
Operating temperature	-5 °C to + 45 °C
Ambient temperature storage	-20 °C to + 60 °C
Operating humidity	5 % to 95 % Non-condensing
Meter	MID Class 1 - EN50470-3
Light beacon	RGB colour indicator
Power limit control	Mode 3 PWM control according ISO/IEC 61851-1
Dimensions	Small: 222 x 382 x 628 mm <i>(only available on Master S Zero and on Slave S)</i> Large: 222 x 382 x 928 mm
Weight	Small: 25 kg Large: 30 Kg
Power Output Management	Embedded Load Management
Type 2 Socket Protection	Locking System

Master

Network connection	10/100TX (TCP-IP)
Interface protocol	OCPP 1.5 (1.6 Optional)
Display HMI	8" anti vandal touch screen
RFID Reader	ISO/IEC 14443 A/B MIFARE Classic/DESFire EV1 ISO 18092 ECMA-340 NFC 16.53MHz

Slave

Master Communication	Ethernet UTP
----------------------	--------------

Models Specifications

Models	Master S Zero	Master S One	Master T One	Master or Slave S	Master or Slave T	
AC power supply	1P + N + PE	1P + N + PE	3P + N + PE	1P + N + PE	3P + N + PE	
AC input voltage	230 VAC +/-10%	230 VAC +/-10%	400 VAC +/-10%	230 VAC +/-10%	400 VAC +/-10%	
Maximum input current	0,15 mA	32 A	32 A	64 A	64 A	
Maximum input power	35 W	7,4 kW	22 kW	14,8 kW	44 kW	
Number of plugs	0	1	1	2	2	
Outlet A	Maximum output current	32 A	32 A	32 A	32 A	
	Maximum output power	7,4 kW	22 kW	7,4 kW	22 kW	
	AC output voltage	230 VAC (1P + N + PE)	400 VAC (3P + N + PE)	230 VAC (1P + N + PE)	400 VAC (3P + N + PE)	
Outlet B	Maximum output current			32 A	32 A	
	Maximum output power			7,4 kW	22 kW	
	AC output voltage			230 VAC (1P + N + PE)	400 VAC (3P + N + PE)	
Connection	Master	Not available	1x Type 2 Socket (lock system)	1x Type 2 Socket (lock system)	Check availability	Check availability
	Slave	Not available	Not available	Not available	2x Type 2 Socket (lock system)	2x Type 2 Socket (lock system)

Optional devices

Low Temperature Kit	-30 °C to +45 °C
Electrical protection Type A	Overcurrent: MCB (curve C) Safety: RCD Type A (30mA)
Electrical protection Type B	Overcurrent: MCB (curve C) Safety: RCD Type B (30mA)
Surge Protection	Four pole transient surge protector IEC 61643-1 (class II)
Type 2 Charging socket	Shutter
Wireless communication <i>(only in Master)</i>	4G LTE/WiFi Hotspot/GPRS/GSM
Anti Vandal Key	
Tethered cable <i>(spring)</i> Cable length: 4m <i>(only available in Slave)</i>	Type 1 + Type 1
	Type 2 + Type 2
Network hub <i>(only available in Master)</i>	Switch TCP ethernet 8 ports
	Switch TCP ethernet 12 ports
RFID Extension	Legic Advant / Legic Prime ISO 15693 / ISO 18092, Sony FeliCa

Dynamic Load Management

Make simultaneous EV charging easier, faster and cheaper

Main problems

EV drivers want to charge their vehicles faster, specially in public and semi-public spaces while charging service providers want to lower their costs.

This situation requires an intelligent system to manage the charge and this is where Dynamic Load Management System (DLM) comes in.

The Solution

Dynamic Load Management (DLM) system is designed for an intelligent energy management of several charging stations that work simultaneously.

DLM allows charging more EVs simultaneously in less time using the available power more efficiently and balancing it among the EV chargers.

It also allows increasing the number of charging stations available over the years.

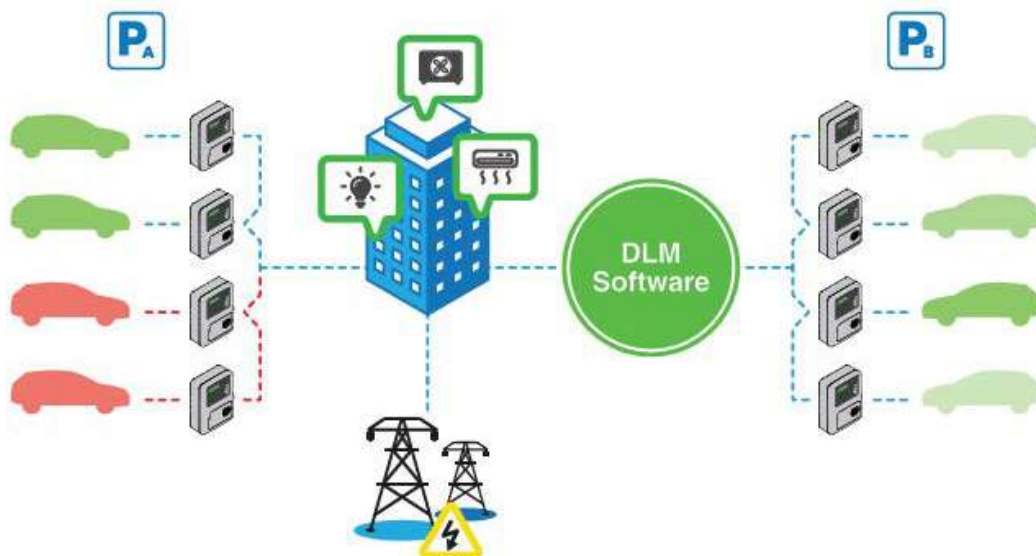

The existence of more EVs charging simultaneously creates new challenges:



- Overloading that causes a blackout due to limited grid capacity.
- High investment to upgrade the installation.
- Not having the possibility to charge the EV's simultaneously.

This system offers two possibilities:



- DLM Standard: when the electric installation is fully dedicated to electric vehicle charging stations.
- DLM Premium: when the charging stations are connected to another facility sharing the maximum power availability.

DLM Standard

- OCPP Ready: Chargers can be controlled by a back office system.
- EV Charging Status: Monitor all chargers with a SCADA screen.
- User Authentication RFID: Increase the security of the system with RFID tags
- Power Monitoring: Check total power management of your installation with a SCADA screen.
- Offline operation: In case of communications problems the system is able to keep charging.

DLM Premium

- DLM Standard features.
- Building energy monitoring: Measure the power used by the building and adjust the power available for charging.
- EV Chargers priority: Set up VIP chargers as a priority charging.
- Power graphic: allow consulting chargers and building historical consumptions.

Designed for

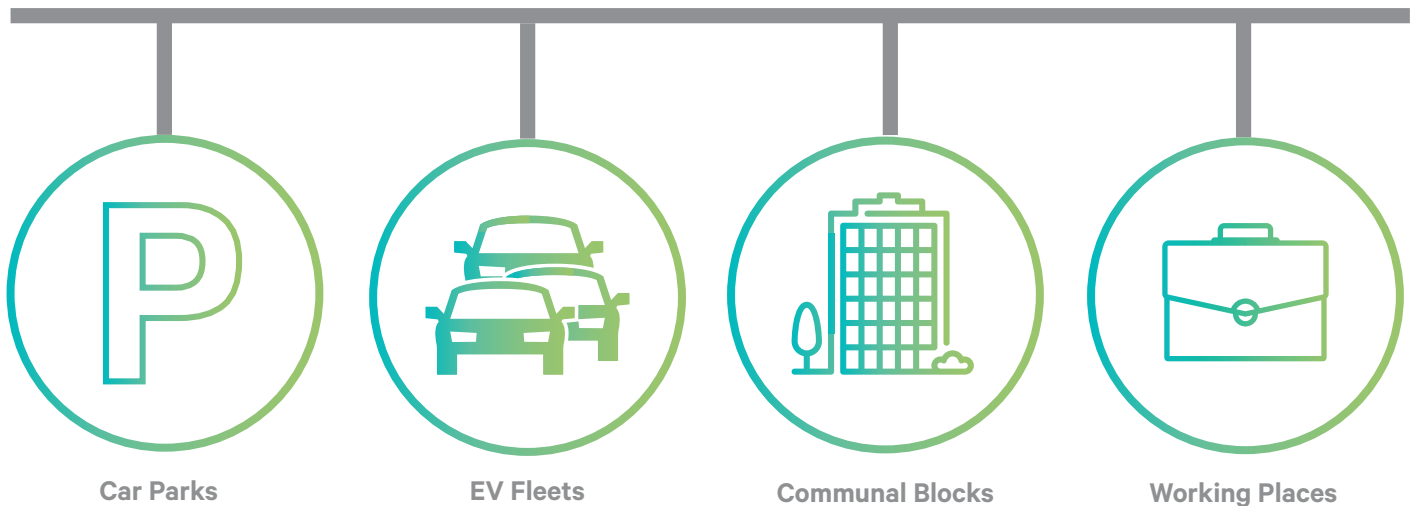

Cosmos (cloud-based platform)

The ultimate tool for monitoring and reporting

Application

Designed by CIRCONTROL to collect and store data from a specific set of EV Chargers for monitoring and reporting. This cloud-based Platform has an easy and intuitive dashboard and offers customisable reports by user, charger, consumption and tariff, including invoices simulation.

Perfect for...

Fleet managers, condominium administrators, car park operators and other stakeholders with similar needs will easily (un)subscribe users, customise reports and use this information to address only the action items that add value and therefore are interesting.



Cosmos is a cloud platform based on OCPP 1.6J that gathers data from a specific set of EV Chargers and helps you create and manage your own charging network. Therefore, monitoring, controlling remotely the chargers and/or reporting processes are simpler and automatic.

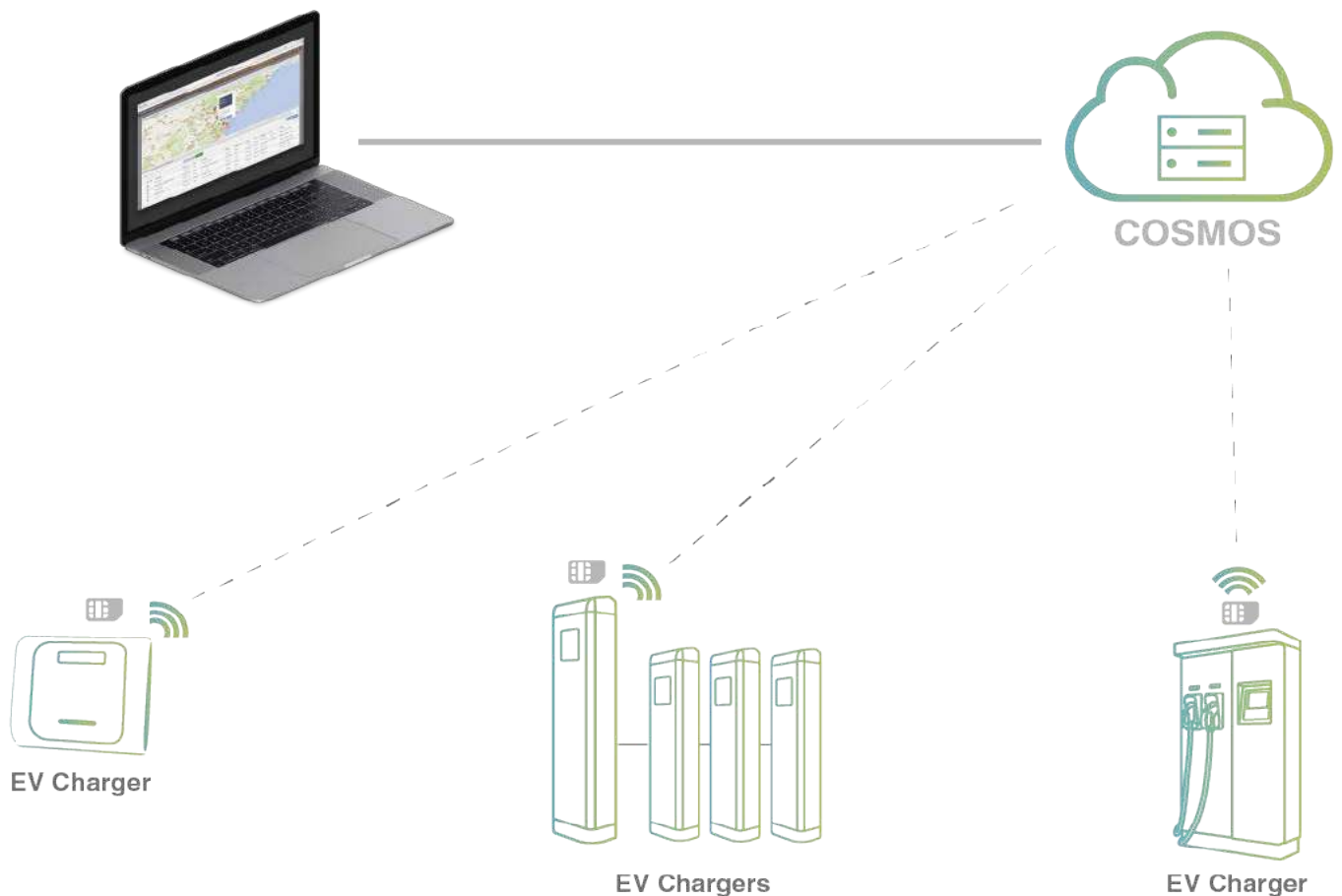

Cosmos cloud-based platform

Benefits



Easy and intuitive dashboard

Obtain easily a general overview and the most significant data about an installation or a group of installations at a simple glance.



Customisable reports

Design, generate and send reports automatically by e-mail, as well as invoices simulations with consumption data, times, rates...



Charging network map

Locate and check your chargers' status on a map in a very easy and quick way.



(Un)subscribe users

Manage the authorized users of your charging network as well as their permissions and profiles as required.



EV charger log display

Reduce the fault resolution time and obtain a quick diagnosis if any charger is not working properly.



Compatible with other brands

Connect other EV chargers, aside from Circontrol's, as long as they comply with OCPP 1.6 protocol.

Licenses

Create your own Partner Network, escalating and personalizing it according to your needs.

	Basic (BL)	Advanced (AL)	Pro (PL)
Configuration (Company, facility, chargers, users...)	—	—	✓
Monitoring of Charging Points	—	✓	✓
Basic control of charging points (start, stop, unlock...)	—	🕒	🕒
Advanced control of charging points (reserve, reboot, get diagnosis, FW upgrade*...)	—	—	🕒
Access historic of reports	✓	✓	✓
Configure user/company reports (company, facility, users, schedule, tariff...)	—	—	✓
Map with the location of the charging points	—	✓	✓
Error automatic reporting	—	—	🕒
Real-time dashboard (widget)	🕒	🕒	🕒

🕒 Coming soon

After Sales Support

“

Customer service is not a department, it is an attitude.

”

We strongly believe that Customer Service is crucial in EV Charging Infrastructure.

On-line technical support, on-site assistance, trainings, documentation and tools, new releases, recommended spare parts and a specific web-based Expert Area are some of the services you will have at your disposal to grant that chargers are always up and running. **This is our main goal.**

+160
Trainings

+2.500
Training hours

+100.000
Kilometres
travelled / year



Mini DC Tester

DC Tester for Fast Charging Stations



Application

The Mini DC Tester is designed to be a service tool for testing Circontrol Fast Charging Infrastructure and help Service Maintainer to provide an effective support.

Concept Design

The Mini DC Tester has the capability to simulate an EV and check all the parts involved during charging process. Its robust housing protects DC Tester from harsh conditions.

The included software provides the engineer with information about each test in order to make his troubleshooting easier.

Product highlights

For Charging Points Maintainers

Clearer and informed

- The Mini DC Tester helps to focus in the issue and informs through the logging system.

Better

- Easy maintenance. Testing all the parts involved in the charging process: EV, power, coms, protocol and procedure.

Faster

- Plug & Play system where you want. The Mini DC Tester is portable and easy to use.

EV Simulation

- Available with CCS and CHAdeMO systems. It makes possible to test both protocols.

Portable

- Its robust design allows carrying the Tester wherever you go or ship it before travel.

Mini DC Tester CCS

Models	Series	Description	Socket type
490276	Raption	CCS 2/CCS 1 Mini DC Tester for RAPTION SERIES	

Mini DC Tester CHAdeMO

Models	Series	Description	Socket type
490275	Raption	CHAdeMO Mini DC Tester for RAPTION SERIES	

Combined Mini DC Tester

Models	Series	Description	Socket type
490277	Raption	Combined Mini DC Tester for RAPTION SERIES	

Spare Parts Kits

for DC Charging Station Raption 50 Series

Application

The Spare Parts Kits are designed for Charging station service maintainers and contain all the recommended components for DC Charger Raption 50 Series.

Concept Design

These kits are a combination of spare parts needed to cover the most common incidences in the field. Each part is packaged separately and clearly identified in a robust protection case making its transportation easier.

The kits also include a Service Manual and information labels in order to store information about the replaced part.



Product highlights

For Charging Points Maintainers

Clearer

- The Spare Part Kits provide all the spare parts recommended by CIRCONTROL for replacement during maintenance. This minimizes the risk of ordering wrong or unnecessary parts.

Better

- Easy maintenance through clear labelling of parts. The Spare Part Kits centralize all the parts required and reduce the variety of components on stock.

Faster

- The Spare Part Kits cover about 90% of the parts involved in incidences in the field and allows resolving most of the possible issues during first assistance.

Cost effective

- Its compact format and flexibility help minimizing logistics and preparations for service calls, saving indirect cost.

Portable

- Its robust design allows carrying the Spare Part Kit wherever you go or ship it before travel.







Low-priced

- Kits are less expensive than the sum of the individual parts.

Spare Parts Kits for Raption 50 Series

Models

GoBox Raption 50 Kit designed with the necessary components to maintain up to 20 chargers. It is supplied in a transportable protection box

Models	Series	Description	Socket type
GoBox Raption 50 Trio T232	TRIO	Kit GoBox Raption 50 TRIO T2S32. CHA+CCS+T2 Socket 32	
GoBox Raption 50 Trio T263	TRIO	Kit GoBox Raption 50 TRIO T2C63. CHA+CCS+T2 Cable 63	
GoBox Raption 50 Duo		Kit GoBox Raption 50 DUO. CHA+CCS	
GoBox Raption 50 CCS T232	CCS	Kit GoBox Raption 50 CCS T2S32. CCS+T2 Socket 32	
GoBox Raption 50 CHA T232	CHA	Kit GoBox Raption 50 CHA T2S32. CHA+T2 Socket 32	
GoBox Raption 50 CCS	CCS	Kit GoBox Raption 50 CCS. CCS	
GoBox Raption 50 CHA	CHA	Kit GoBox Raption 50 CHA. CHA	

Protection Kit Raption 50 Kit designed with the necessary protections to maintain up to 20 chargers

Models	Series	Description
Protection Kit Raption 50 RCD A	RCD A	Protection Kit Raption 50 RCD Class A
Protection Kit Raption 50 RCD A 32	RCD A	Protection Kit Raption 50 RCD Class A + MCB for T2 Socket 32
Protection Kit Raption 50 RCD A 63	RCD A	Protection Kit Raption 50 RCD Class A + MCB for T2 Cable 63
Protection Kit Raption 50 RCD B	RCD B	Protection Kit Raption 50 RCD Class B
Protection Kit Raption 50 RCD B 32	RCD B	Protection Kit Raption 50 RCD Class B + MCB for T2 Socket 32
Protection Kit Raption 50 RCD B 63	RCD B	Protection Kit Raption 50 RCD Class B + MCB for T2 Cable 63

Recommended Spare Parts

Raption 50 Recommended Spare Parts to maintain up to 20 chargers. One line per group must be selected according to Raption 50 model

Group	Model	Description
1	SPQCR050TRIO32	GoBox Raption 50 Trio T232
	SPQCR050TRIO63	GoBox Raption 50 Trio T263
	SPQCR050DUO	GoBox Raption 50 Duo
	SPQCR050CCS32	GoBox Raption 50 CCS T232
	SPQCR050CHA32	GoBox Raption 50 CHA T232
	SPQCR050CCS	GoBox Raption 50 CCS
	SPQCR050CHA	GoBox Raption 50 CHA
2	SPQCR050RCDA	Protection Kit Raption 50 RCD A
	SPQCR050RCDA32	Protection Kit Raption 50 RCD A 32
	SPQCR050RCDA63	Protection Kit Raption 50 RCD A 63
	SPQCR050RCDB	Protection Kit Raption 50 RCD B
	SPQCR050RCDB32	Protection Kit Raption 50 RCD B 32
3	SPQCR050RCDB63	Protection Kit Raption 50 RCD B 63
	SP3800000049	Type 2 Plug 63A
4	VA2400000041	Mode 3 Type 2 Socket 32A
	SP3800000059	CCS Plug Mode 4 125A
5	SP3800000079	Chademo Plug Mode 4 125A



CIRCONTROL offers intelligent charging solutions for electric vehicles with a wide product range that suits with every market need.

We offer products designed for public, private and domestic market. We installed our first EV charger in 2008 and since then we have reached 50.000 charging points in 56 different countries.

50k
Charging points

56
Countries

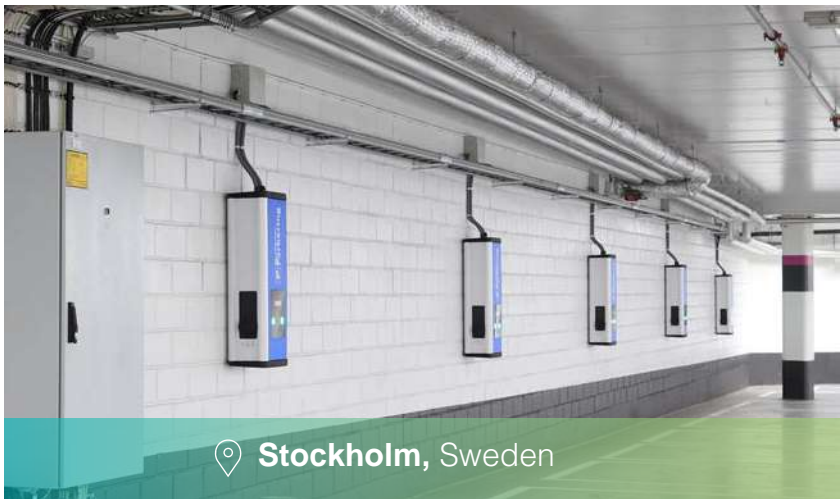

📍 **Stockholm, Sweden**



📍 **Ibiza, Spain**



📍 **Heathrow Airport, United Kingdom**



📍 **Dobbiaco, Italy**



📍 **Dubai, United Arab Emirates**

Notes

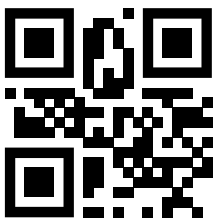

Circontrol has a network of distributors and representative agents all over the world, for further information approach with:

Headquarter Address:
C/ Innovació, 3 Industrial Park Can Mitjans
08232 Viladecavalls (Barcelona) Spain

Phone: (+34) 937 362 940
Fax: (+34) 937 362 941
Mail: circontrol@circontrol.com
Website: circontrol.com

